

NewNight® CurveLight conversion kit

Information

The NewNight® CurveLight conversion kit for multipurpose retrofitting and modernisation of conventional operated existing lighting systems to modernest LED light technology, in combination with switching- and control technology. Optimized for the illumination of historical lamps, pendant lamps, bell- and shade lamps as well as post-top and side-entry lamps with a recommended mounting height of maximum 6m. The turnable NewNight® CurveLight conversion kit finds its application preferably in old town quarter as well as in residential-side- and traffic-calmed streets. Also in historical city centers, pedestrian zones and park- and green areas.

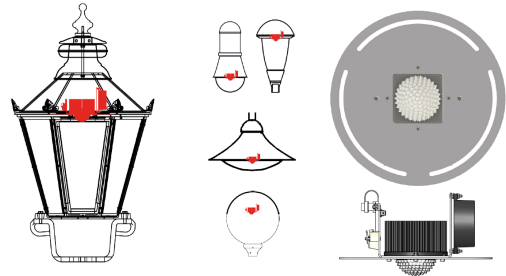

Technical Informations

Betriebsgeräte:	IP66 ENEC
Gehäusemaße :	Ø200 mm x 86 mm
Montage:	The NewNight® 3LENS PIN-Module conversion kit is installed with using a luminaire-specific mounting plate on pre-assembled press bolts (120° split ratio). The mounting plate has to be adapted to the geometrical condition of the lamp and / or the situation of installation to be obtained. Due to the turnable equipment carrier of the NewNight® 3LENS PIN-Module conversion kit in combination with lenses of the ME series, the created light can be transported directly. The Dark Sky guideline is fulfilled. A huge variety of symmetrical and asymmetrical light distributions are available.
Schutzart Leuchte :	I (SKII)
Technische Informationen :	<ul style="list-style-type: none">• Ready for connection and easy assembling LED conversion kit on powder-coated gear tray made of aluminium• Performance protection class 1 (optional protection class 2)• Highest efficiency of all system components• UV resistant high performance lens made of optical silicone• Vibration resistant
Überspannungsschutz :	4kv • Optional: Überspannungsschutz bis 10kv Serial od. Paralle
Zubehör:	Luminaire-specific mounting plates made of aluminium Surface variants: <ul style="list-style-type: none">• natural-raw• varnished according to RAL• powder-coated according to RAL
Zulässige Betriebsspannung:	100-240VAC, 50/60Hz
Zulässige Umgebungstemperatur:	- 30°C up to 60°C

BRAUN Lighting Solutions e. K. is a participant in the export initiative "Energie Effizienz – made in Germany", initiated by the Federal Ministry for the Economy and Technology. Due to the complexity of the many possible combinations of drivers and LED modules, the values shown for technical LED parameters, including performance parameters, are typical. Actual values of specific products in specific configurations may vary from these typical values. The information and diagrams contained in this document do not constitute an offer or contractual obligation. Product parameters may change as a result of technical innovation and will be undertaken without prior notice. Our manufacturing conforms to DIN EN and VDE regulations; the product conforms to European EMC regulations.

BRAUN Lighting Solutions
Nunsdorfer Ring 2-10
12277 Berlin
Germany

 www.braun.lighting
 info@braun-lighting.com
 +49 (0)30 7 007 763-100
 +49 (0)30 7 007 763-101



NewNight® CurveLight conversion kit

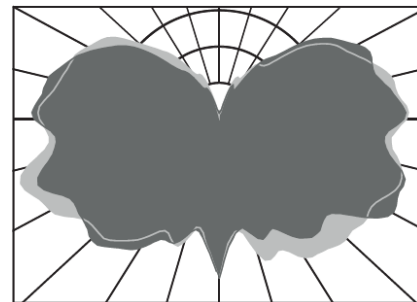
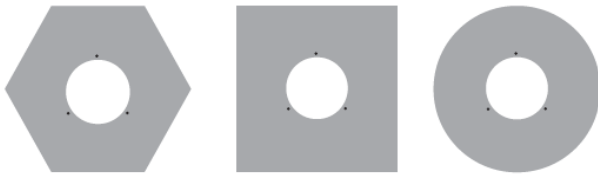
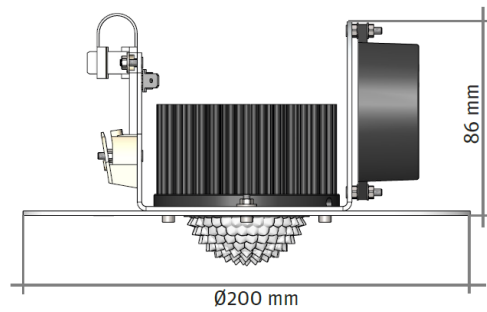

Luminaire-specific mounting plates of aluminium

Surface finishes:

- Natural-raw
- painted according to RAL
- powder-coated to RAL
(optional accessories)

BRAUN Lighting Solutions e. K. is a participant in the export initiative "Energie Effizienz – made in Germany", initiated by the Federal Ministry for the Economy and Technology. Due to the complexity of the many possible combinations of drivers and LED modules, the values shown for technical LED parameters, including performance parameters, are typical. Actual values of specific products in specific configurations may vary from these typical values. The information and diagrams contained in this document do not constitute an offer or contractual obligation. Product parameters may change as a result of technical innovation and will be undertaken without prior notice. Our manufacturing conforms to DIN EN and VDE regulations; the product conforms to European EMC regulations.

BRAUN Lighting Solutions
Nunsdorfer Ring 2-10
12277 Berlin
Germany

 www.braun.lighting
 info@braun-lighting.com
 +49 (0)30 7 007 763-100
 +49 (0)30 7 007 763-101



NewNight® CurveLight conversion kit

» Variante ON/OFF 450mA:

- Leistung: 19 Watt
 - Lichtstrom: 2030lm
 - Manuell über 10stufigen Codierschalter: Nein
 - 0-10V | 1-10V Schnittstelle | Dim-to-Off: Ja
 - Dali Schnittstelle: Nein
 - Halbnachtschaltung über Steuerspannung 230Vac: Nein
 - einstellbare Leistungen in Watt: Nein
 - ThermoProtect System: Ja
 - Leistungsreduzierung zur Absenkung des Lichtstroms um 50%: Nein
 - Dimmung erfolgt manuell über 10stufigen Codierschalter: Nein
-

» Variante Basic 450mA:

- Leistung: 3 - 19 Watt
 - Manuell über 10stufigen Codierschalter: Ja
 - 0-10V | 1-10V Schnittstelle | Dim-to-Off: Nein
 - Dali Schnittstelle: Nein
 - Halbnachtschaltung über Steuerspannung 230Vac: Nein
 - einstellbare Leistungen in Watt: Ja
 - ThermoProtect System: Ja
 - Leistungsreduzierung zur Absenkung des Lichtstroms um 50%: Nein
 - Dimmung erfolgt manuell über 10stufigen Codierschalter: Nein
 - Lichtstrom: 2146lm
-

» Variante Light 450mA:



- Leistung: 3 - 19 Watt
 - Lichtstrom: 2146lm
 - Manuell über 10stufigen Codierschalter: Ja
 - 0-10V | 1-10V Schnittstelle | Dim-to-Off: Nein
 - Dali Schnittstelle: Nein
 - Halbnachtschaltung über Steuerspannung 230Vac: Ja
 - einstellbare Leistungen in Watt: Ja
 - ThermoProtect System: Ja
 - Leistungsreduzierung zur Absenkung des Lichtstroms um 50%: Nein
 - Dimmung erfolgt manuell über 10stufigen Codierschalter: Ja
-

» Variante Light50 450mA:

- Manuell über 10stufigen Codierschalter: Nein
 - 0-10V | 1-10V Schnittstelle | Dim-to-Off: Nein
 - Dali Schnittstelle: Nein
 - Halbnachtschaltung über Steuerspannung 230Vac: Ja
 - einstellbare Leistungen in Watt: Nein
 - ThermoProtect System: Ja
 - Leistungsreduzierung zur Absenkung des Lichtstroms um 50%: Ja
 - Dimmung erfolgt manuell über 10stufigen Codierschalter: Nein
-

BRAUN Lighting Solutions e. K. is a participant in the export initiative "Energie Effizienz – made in Germany", initiated by the Federal Ministry for the Economy and Technology. Due to the complexity of the many possible combinations of drivers and LED modules, the values shown for technical LED parameters, including performance parameters, are typical. Actual values of specific products in specific configurations may vary from these typical values. The information and diagrams contained in this document do not constitute an offer or contractual obligation. Product parameters may change as a result of technical innovation and will be undertaken without prior notice. Our manufacturing conforms to DIN EN and VDE regulations; the product conforms to European EMC regulations.

BRAUN Lighting Solutions
Nunsdorfer Ring 2-10
12277 Berlin
Germany

 www.braun.lighting
 info@braun-lighting.com
 +49 (0)30 7 007 763-100
 +49 (0)30 7 007 763-101



NewNight® CurveLight conversion kit

» Variante DALI 450mA:

- Leistung: 3 - 19 Watt
 - Lichtstrom: 2279lm
 - Manuell über 10stufigen Codierschalter: Nein
 - 0-10V | 1-10V Schnittstelle | Dim-to-Off: Nein
 - Dali Schnittstelle: Ja
 - Halbnachtschaltung über Steuerspannung 230Vac: Ja
 - einstellbare Leistungen in Watt: Ja
 - ThermoProtect System: Ja
 - Leistungsreduzierung zur Absenkung des Lichtstroms um 50%: Nein
 - Dimmung erfolgt manuell über 10stufigen Codierschalter: Nein
-

» Variante ON/OFF 700mA:

- Leistung: 30 Watt
 - Lichtstrom: 2967lm
 - Manuell über 10stufigen Codierschalter: Nein
 - 0-10V | 1-10V Schnittstelle | Dim-to-Off: Ja
 - Dali Schnittstelle: Nein
 - Halbnachtschaltung über Steuerspannung 230Vac: Nein
 - einstellbare Leistungen in Watt: Nein
 - ThermoProtect System: Ja
 - Leistungsreduzierung zur Absenkung des Lichtstroms um 50%: Nein
 - Dimmung erfolgt manuell über 10stufigen Codierschalter: Nein
-

» Variante Basic 700mA:





- Leistung: 4,5 - 30 Watt
 - Lichtstrom: 3137lm
 - Manuell über 10stufigen Codierschalter: Ja
 - 0-10V | 1-10V Schnittstelle | Dim-to-Off: Nein
 - Dali Schnittstelle: Nein
 - Halbnachtschaltung über Steuerspannung 230Vac: Nein
 - einstellbare Leistungen in Watt: Ja
 - ThermoProtect System: Ja
 - Leistungsreduzierung zur Absenkung des Lichtstroms um 50%: Nein
 - Dimmung erfolgt manuell über 10stufigen Codierschalter: Nein
-

» Variante Light 700mA:

- Leistung: 4,5 - 30 Watt
 - Lichtstrom: 3209lm
 - Manuell über 10stufigen Codierschalter: Ja
 - 0-10V | 1-10V Schnittstelle | Dim-to-Off: Nein
 - Dali Schnittstelle: Nein
 - Halbnachtschaltung über Steuerspannung 230Vac: Ja
 - einstellbare Leistungen in Watt: Ja
 - ThermoProtect System: Ja
 - Leistungsreduzierung zur Absenkung des Lichtstroms um 50%: Nein
 - Dimmung erfolgt manuell über 10stufigen Codierschalter: Ja
-

BRAUN Lighting Solutions e. K. is a participant in the export initiative "Energie Effizienz – made in Germany", initiated by the Federal Ministry for the Economy and Technology. Due to the complexity of the many possible combinations of drivers and LED modules, the values shown for technical LED parameters, including performance parameters, are typical. Actual values of specific products in specific configurations may vary from these typical values. The information and diagrams contained in this document do not constitute an offer or contractual obligation. Product parameters may change as a result of technical innovation and will be undertaken without prior notice. Our manufacturing conforms to DIN EN and VDE regulations; the product conforms to European EMC regulations.

BRAUN Lighting Solutions
Nunsdorfer Ring 2-10
12277 Berlin
Germany

 www.braun.lighting
 info@braun-lighting.com
 +49 (0)30 7 007 763-100
 +49 (0)30 7 007 763-101



NewNight® CurveLight conversion kit

» Variante Light50 700mA:





- Leistung: 15 - 30 Watt
 - Lichtstrom: 3272lm
 - Manuell über 10stufigen Codierschalter: Nein
 - 0-10V | 1-10V Schnittstelle | Dim-to-Off: Nein
 - Dali Schnittstelle: Nein
 - Halbnachtschaltung über Steuerspannung 230Vac: Ja
 - einstellbare Leistungen in Watt: Nein
 - ThermoProtect System: Ja
 - Leistungsreduzierung zur Absenkung des Lichtstroms um 50%: Ja
 - Dimmung erfolgt manuell über 10stufigen Codierschalter: Nein
-

» Variante DALI 700mA:

- Leistung: 4,5 - 30 Watt
 - Lichtstrom: 3331lm
 - Manuell über 10stufigen Codierschalter: Nein
 - 0-10V | 1-10V Schnittstelle | Dim-to-Off: Nein
 - Dali Schnittstelle: Ja
 - Halbnachtschaltung über Steuerspannung 230Vac: Ja
 - einstellbare Leistungen in Watt: Ja
 - ThermoProtect System: Ja
 - Leistungsreduzierung zur Absenkung des Lichtstroms um 50%: Nein
 - Dimmung erfolgt manuell über 10stufigen Codierschalter: Nein
-

BRAUN Lighting Solutions e. K. is a participant in the export initiative "Energie Effizienz – made in Germany", initiated by the Federal Ministry for the Economy and Technology. Due to the complexity of the many possible combinations of drivers and LED modules, the values shown for technical LED parameters, including performance parameters, are typical. Actual values of specific products in specific configurations may vary from these typical values. The information and diagrams contained in this document do not constitute an offer or contractual obligation. Product parameters may change as a result of technical innovation and will be undertaken without prior notice. Our manufacturing conforms to DIN EN and VDE regulations; the product conforms to European EMC regulations.

BRAUN Lighting Solutions
Nunsdorfer Ring 2-10
12277 Berlin
Germany

 www.braun.lighting
 info@braun-lighting.com
 +49 (0)30 7 007 763-100
 +49 (0)30 7 007 763-101

