

# LUNA LED-streetLight (large)

## Information

Suitable for residential streets, residential streets, parking lots as well as bike paths, footpaths and green areas. Illumination for one-sided or two-sided arrangement of poles, even with a lower mounting height and wide distances.

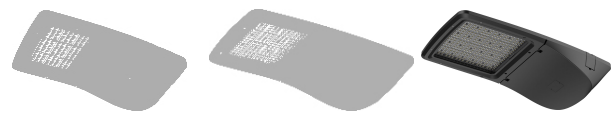

## Technical Informations

Betriebsgeräte:	BRAUN® Cluster-Modul 24
Breite:	328 mm
CRI :	> 80
Farbtemperaturen:	3000K, 4000K, 5000K, 5700K
Gehäuse:	Die-cast aluminum
Gewicht:	ca. 8,5 kg
Höhe:	120 mm
Länge:	780 mm
LED-Raum :	Protection level IP65
Leistungsaufnahme :	180 Watt   200 Watt   240 Watt
Neigungswinkel einstellbar :	adjustable +15°/-15
Oberfläche:	powder-coated (self-clean)
Optische Abdeckung :	PMMA (IK10)
Schutzart Leuchte :	IP 65
Schutzklasse :	SK I (optional SK II)

BRAUN Lighting Solutions e. K. is a participant in the export initiative "Energie Effizienz – made in Germany", initiated by the Federal Ministry for the Economy and Technology. Due to the complexity of the many possible combinations of drivers and LED modules, the values shown for technical LED parameters, including performance parameters, are typical. Actual values of specific products in specific configurations may vary from these typical values. The information and diagrams contained in this document do not constitute an offer or contractual obligation. Product parameters may change as a result of technical innovation and will be undertaken without prior notice. Our manufacturing conforms to DIN EN and VDE regulations; the product conforms to European EMC regulations.

BRAUN Lighting Solutions  
Nunsdorfer Ring 2-10  
12277 Berlin  
Germany

www.braun.lighting  
info@braun-lighting.com  
+49 (0)30 7 007 763-100  
+49 (0)30 7 007 763-101



# LUNA LED-streetLight (large)

Technische Informationen :	<ul style="list-style-type: none"> <li>• Tool-free opening of the luminaire</li> <li>• New low-glare lens system</li> <li>• Tool-free repair on-site</li> <li>• Installation: vertical or horizontal</li> <li>• Fall protection (arrestor cable)</li> <li>• Tilting angle adjustable between -15° and +15° (integrated alignment aid)</li> <li>• Highest efficiency of all system components</li> <li>• Power-Off Protection</li> <li>• Vibration-resistant</li> </ul>
Verwendung:	Street, settlement and district lighting
Zulässige Betriebsspannung:	100-240VAC, 50/60Hz
Zulässige Umgebungstemperatur:	- 40°C up to 50°C

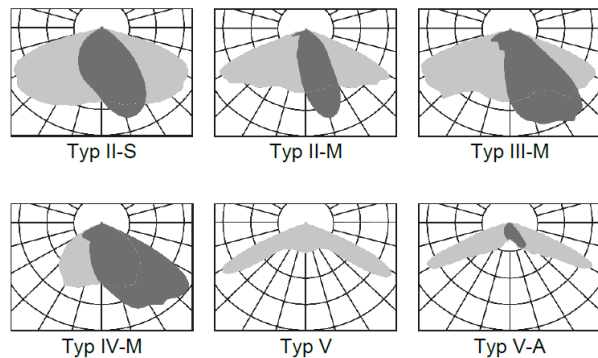
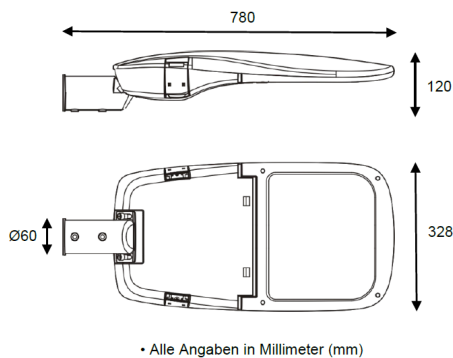

## Variants

BRAUN Lighting Solutions e. K. is a participant in the export initiative "Energie Effizienz – made in Germany", initiated by the Federal Ministry for the Economy and Technology. Due to the complexity of the many possible combinations of drivers and LED modules, the values shown for technical LED parameters, including performance parameters, are typical. Actual values of specific products in specific configurations may vary from these typical values. The information and diagrams contained in this document do not constitute an offer or contractual obligation. Product parameters may change as a result of technical innovation and will be undertaken without prior notice. Our manufacturing conforms to DIN EN and VDE regulations; the product conforms to European EMC regulations.

# LUNA LED-streetLight (large)

---

## » Variante 180 Watt:

---

- Typ II-S luminous flux: 25560 lm
  - Type II-M luminous flux: 25920 lm
  - Typ III-M luminous flux: 23940 lm
  - Typ IV-M luminous flux: 25560 lm
  - Typ V luminous flux: 24660 lm
  - Typ V-A lumious flux: 24660 lm
- 

## » Variante 200 Watt:

---

- Typ II-S luminous flux: 27600 lm
  - Type II-M luminous flux: 27800 lm
  - Typ III-M luminous flux: 26200 lm
  - Typ IV-M luminous flux: 27000 lm
  - Typ V luminous flux: 26000 lm
  - Typ V-A lumious flux: 26000 lm
- 

## » Variante 240 Watt:





---

- Typ II-S luminous flux: 31440 lm
  - Type II-M luminous flux: 32640 lm
  - Typ III-M luminous flux: 30690 lm
  - Typ IV-M luminous flux: 30720 lm
  - Typ V luminous flux: 30480 lm
  - Typ V-A lumious flux: 30480 lm
- 

BRAUN Lighting Solutions e. K. is a participant in the export initiative "Energie Effizienz – made in Germany", initiated by the Federal Ministry for the Economy and Technology. Due to the complexity of the many possible combinations of drivers and LED modules, the values shown for technical LED parameters, including performance parameters, are typical. Actual values of specific products in specific configurations may vary from these typical values. The information and diagrams contained in this document do not constitute an offer or contractual obligation. Product parameters may change as a result of technical innovation and will be undertaken without prior notice. Our manufacturing conforms to DIN EN and VDE regulations; the product conforms to European EMC regulations.

---

BRAUN Lighting Solutions  
Nunsdorfer Ring 2-10  
12277 Berlin  
Germany

 [www.braun.lighting](http://www.braun.lighting)  
 [info@braun-lighting.com](mailto:info@braun-lighting.com)  
 +49 (0)30 7 007 763-100  
 +49 (0)30 7 007 763-101

